

## DS-2CD2766G2-IZS

6 MP AcuSense Powered-by-DarkFighter Motorized Varifocal Dome Network Camera

### AcuSense

Powered by

**DarkFighter**



Empowered by deep learning algorithms, Hikvision AcuSense technology brings human and vehicle targets classification alarms to front- and back-end devices. The system focuses on human and vehicle targets, vastly improving alarm efficiency and effectiveness.

- High quality imaging with 6 MP resolution
- Motorized varifocal lens for easy installation and monitoring
- Excellent low-light performance via powered-by-DarkFighter technology
- Efficient H.265+ compression technology
- Clear imaging against strong back light due to 120 dB true WDR technology
- Focus on human and vehicle targets classification based on deep learning
- Audio and alarm interface available
- Water and dust resistant (IP66) and vandal proof (IK10)



## ▪ Specification

| Camera                 |  |
|------------------------|--|
| Image Sensor           | 1/2.4" Progressive Scan CMOS   |
| Wide Dynamic Range     | 120 dB   |
| Min. Illumination      | Color: 0.003 Lux @ (F1.4, AGC ON), B/W: 0 Lux with IR  |
| Shutter Speed          | 1/3 s to 1/100,000 s   |
| Slow Shutter           | Yes  |
| P/N                    | P/N  |
| Day & Night            | IR cut filter  |
| Angle Adjustment       | Pan: 0° to 355°, tilt: 0° to 75°, rotate: 0° to 355°   |
| Power-off Memory       | Yes  |
| Lens                   |  |
| Lens Type              | Varifocal lens, motorized lens, 2.8 to 12 mm   |
| Iris Type              | Fixed  |
| Focal Length & FOV     | 2.8 to 12 mm, horizontal FOV 99° to 35°, vertical FOV 53° to 20°, diagonal FOV 117° to 41°   |
| Aperture               | F1.4   |
| Lens Mount             | Ø14  |
| DORI                   |  |
| DORI                   | 2.8 to 12 mm:<br>Wide: D: 80 m, O: 31 m, R: 16 m, I: 8 m<br>Tele: D: 210 m, O: 83 m, R: 42 m, I: 21 m  |
| Illuminator            |  |
| Supplement Light Type  | IR   |
| IR Range               | Up to 40 m   |
| IR Wavelength          | 850 nm   |
| Smart Supplement Light | Yes  |
| Video                  |  |
| Max. Resolution        | 3200 × 1800  |
| Main Stream            | 50 Hz: 25 fps (3200 × 1800, 2688 × 1520, 1920 × 1080, 1280 × 720)<br>60 Hz: 30 fps (3200 × 1800, 2688 × 1520, 1920 × 1080, 1280 × 720)   |
| Sub-Stream             | 50 Hz: 25 fps (640 × 480, 640 × 360)<br>60 Hz: 30 fps (640 × 480, 640 × 360)   |
| Third Stream           | 50 Hz: 10 fps (1920 × 1080, 1280 × 720, 640 × 480, 640 × 360)<br>60 Hz: 10 fps (1920 × 1080, 1280 × 720, 640 × 480, 640 × 360)<br>*Third stream is supported under certain settings. |
| Video Compression      | Main stream: H.265/H.264/H.264+/H.265+<br>Sub-stream: H.265/H.264/MJPEG<br>Third stream: H.265/H.264<br>*Third stream is supported under certain settings.                           |
| Video Bit Rate         | 32 Kbps to 16 Mbps   |
| H.264 Type             | Baseline Profile/Main Profile/High Profile   |
| H.265 Type             | Main Profile   |
| H.264+                 | Main stream supports   |

|                             |  |
|-----------------------------|--|
| H.265+                      | Main stream supports   |
| Bit Rate Control            | CBR/VBR  |
| Scalable Video Coding (SVC) | H.264 and H.265 encoding   |
| Region of Interest (ROI)    | 1 fixed region for main stream and sub-stream  |
| <b>Audio</b>                |  |
| Environment Noise Filtering | Yes  |
| Audio Sampling Rate         | 8 kHz/16 kHz/32 kHz/44.1 kHz/48 kHz  |
| Audio Compression           | G.711ulaw/G.711alaw/G.722.1/G.726/MP2L2/PCM/MP3/AAC  |
| Audio Bit Rate              | 64 Kbps (G.711ulaw/G.711alaw)/16 Kbps (G.722.1)/16 Kbps (G.726)/32 to 192 Kbps (MP2L2)/8 to 320 Kbps (MP3)/16 to 64 Kbps (AAC)   |
| Audio Type                  | Mono sound   |
| <b>Network</b>              |  |
| Web Browser                 | Plug-in required live view: IE 10+<br>Plug-in free live view: Chrome 57.0+, Firefox 52.0+<br>Local service: Chrome 57.0+, Firefox 52.0+  |
| Protocols                   | TCP/IP, ICMP, HTTP, HTTPS, FTP, DHCP, DNS, DDNS, RTP, RTSP, NTP, UPnP, SMTP, IGMP, 802.1X, QoS, IPv4, IPv6, UDP, Bonjour, SSL/TLS, PPPoE, SNMP, ARP  |
| Simultaneous Live View      | Up to 6 channels   |
| API                         | Open Network Video Interface (PROFILE S, PROFILE G, PROFILE T), ISAPI, SDK   |
| User/Host                   | Up to 32 users. 3 user levels: administrator, operator and user  |
| Security                    | Password protection, complicated password, HTTPS encryption, IP address filter, Security Audit Log, basic and digest authentication for HTTP/HTTPS, TLS 1.1/1.2, WSSE and digest authentication for Open Network Video Interface                                 |
| Network Storage             | NAS (NFS, SMB/CIFS), auto network replenishment (ANR)<br>Together with high-end Hikvision memory card, memory card encryption and health detection are supported.  |
| Client                      | iVMS-4200, Hik-Connect, Hik-Central  |
| <b>Image</b>                |  |
| Day/Night Switch            | Day, Night, Auto, Schedule   |
| Target Cropping             | Yes  |
| Image Enhancement           | BLC, HLC, 3D DNR   |
| Image Parameters Switch     | Yes  |
| Image Settings              | Rotate mode, saturation, brightness, contrast, sharpness, gain, white balance adjustable by client software or web browser   |
| SNR                         | ≥ 52 dB  |
| <b>Interface</b>            |  |
| Alarm                       | 1 input, 1 output (max. 24 VDC/24 VAC, 1 A)  |
| Audio                       | 1 input (line in), 3.5 mm connector, max. input amplitude: 3.3 Vpp, input impedance: 4.7 KΩ, interface type: non-equilibrium;<br>1 output (line out), 3.5 mm connector, max. output amplitude: 3.3 Vpp, output impedance: 100 Ω, interface type: non-equilibrium |
| On-Board Storage            | Built-in memory card slot, support microSD card, up to 256 GB  |
| Hardware Reset              | Yes  |
| Ethernet Interface          | 1 RJ45 10 M/100 M self-adaptive Ethernet port  |

| Event                            |   |
|----------------------------------|---|
| Basic Event                      | Motion detection (human and vehicle targets classification), video tampering alarm, exception   |
| Smart Event                      | Scene change detection  |
| Deep Learning Function           |   |
| Face Capture                     | Yes   |
| Perimeter Protection             | Line crossing detection, intrusion detection, region entrance detection, region exiting detection<br>Supports human and vehicle targets classification  |
| General                          |   |
| Web Client Language              | 33 languages<br>English, Russian, Estonian, Bulgarian, Hungarian, Greek, German, Italian, Czech, Slovak, French, Polish, Dutch, Portuguese, Spanish, Romanian, Danish, Swedish, Norwegian, Finnish, Croatian, Slovenian, Serbian, Turkish, Korean, Traditional Chinese, Thai, Vietnamese, Japanese, Latvian, Lithuanian, Portuguese (Brazil), Ukrainian |
| Software Reset                   | Yes   |
| General Function                 | Anti-flicker, heartbeat, mirror, privacy mask, flash log, password reset via email, pixel counter   |
| Linkage Method                   | Upload to FTP/NAS/memory card, notify surveillance center, send email, trigger recording, trigger capture, trigger alarm output, audible warning  |
| Storage Conditions               | -30 °C to 60 °C (-22 °F to 140 °F). Humidity 95% or less (non-condensing)   |
| Startup and Operating Conditions | -30 °C to 60 °C (-22 °F to 140 °F). Humidity 95% or less (non-condensing)   |
| Power Supply                     | 12 VDC ± 25%<br>PoE: 802.3af, Class 3   |
| Power Consumption and Current    | 12 VDC, 0.88 A, max. 10.5 W<br>PoE (802.3af, 36 V to 57 V), 0.35 A to 0.22 A, max. 12.5 W   |
| Power Interface                  | Two-core terminal block   |
| Camera Material                  | Metal   |
| Camera Dimension                 | Ø153.5 mm × 133.2 mm (Ø6.0" × 5.2")   |
| Package Dimension                | 244 mm × 174 mm × 173 mm (9.6" × 6.9" × 6.8")   |
| Camera Weight                    | Approx. 1110 g (2.4 lb.)  |
| With Package Weight              | Approx. 1729 g (3.8 lb.)  |
| Firmware Version                 | V5.5.113  |
| Approval                         |   |
| Protection                       | IP66 (IEC 60529-2013), IK10 (IEC 62262:2002)  |
| EMC                              | CE-EMC (EN 55032: 2015, EN 61000-3-2: 2014, EN 61000-3-3: 2013, EN 50130-4: 2011 +A1: 2014); RCM (AS/NZS CISPR 32: 2015); KC (KN 32: 2015, KN 35: 2015)   |
| Safety                           | UL (UL 60950-1); CB (IEC 60950-1:2005 + Am 1:2009 + Am 2:2013); CE-LVD (EN 60950-1:2005 + Am 1:2009 + Am 2:2013)  |
| Environment                      | CE-RoHS (2011/65/EU); WEEE (2012/19/EU); Reach (Regulation (EC) No 1907/2006)   |

#### ▪ Available Model

DS-2CD2766G2-IZS (2.8 to 12 mm)

DS-2CD2766G2-IZS (2.8 to 12 mm)(Black)



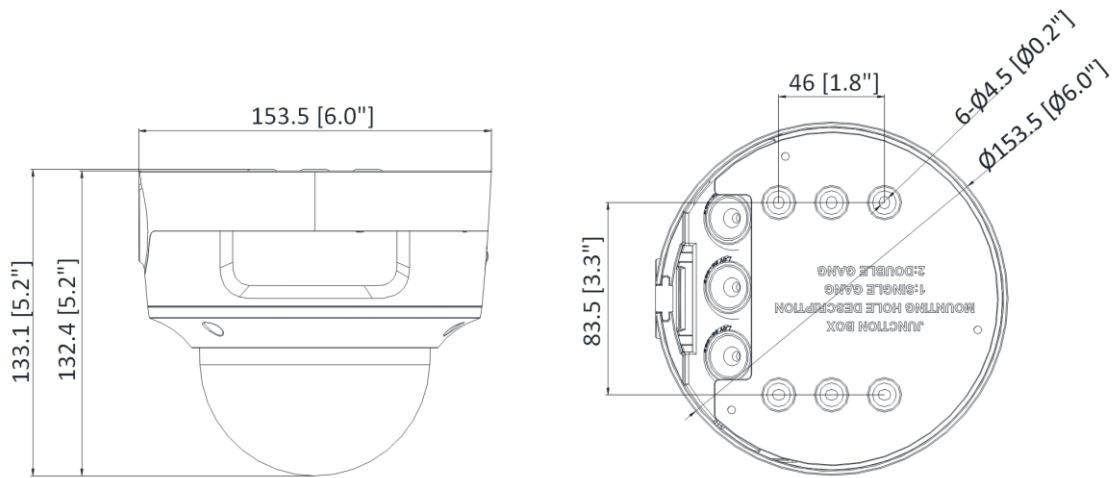



▪ **Dimension**



Unit: mm (inch)

▪ **Accessory**

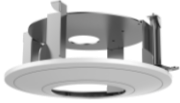
▪ **Optional**

| DS-1473ZJ-155B<br>Wall Mount  | DS-1473ZJ-155<br>Wall Mount   | DS-1476ZJ-SUS<br>Corner Mount   | DS-1475ZJ-SUS<br>Vertical Pole<br>Mount   | DS-1227ZJ-DM37<br>In-Ceiling Mount  |
|---|---|---|---|---|
|  |  |  |  |  |
| DS-1471ZJ-155<br>Pendant Mount  |   |   |   |   |
|  |   |   |   |   |

Distributed by

**HIKVISION®****Headquarters**

No.555 Qianmo Road, Binjiang District,  
Hangzhou 310051, China  
T +86-571-8807-5998  
overseasbusiness@hikvision.com

**Hikvision USA**  
T +1-909-895-0400  
sales.usa@hikvision.com

**Hikvision Australia**  
T +61-2-8599-4233  
salesau@hikvision.com

**Hikvision India**  
T +91-22-28469900  
sales@pramahikvision.com

**Hikvision Canada**  
T +1-866-200-6690  
sales.canada@hikvision.com

**Hikvision Thailand**  
T +662-275-9949  
sales.thailand@hikvision.com

**Hikvision Europe**  
T +31-23-5542770  
sales.eu@hikvision.com

**Hikvision Italy**  
T +39-0438-6902  
info.it@hikvision.com

**Hikvision Brazil**  
T +55 11 3318-0050  
Latam.support@hikvision.com

**Hikvision Turkey**  
T +90 (216)521 7070- 7074  
sales.tr@hikvision.com

**Hikvision Malaysia**  
T +601-7652-2413  
sales.my@hikvision.com

**Hikvision UK & Ireland**  
T +01628-902140  
sales.uk@hikvision.com

**Hikvision South Africa**  
Tel: +27 (10) 0351172  
sale.africa@hikvision.com

**Hikvision France**  
T +33(0)1-85-330-450  
info.fr@hikvision.com

**Hikvision Kazakhstan**  
T +7-727-9730667  
nikia.panfilov@hikvision.ru

**Hikvision Vietnam**  
T +84-974270888  
sales.vt@hikvision.com

**Hikvision UAE**  
T +971-4-4432090  
salesme@hikvision.com

**Hikvision Singapore**  
T +65-6684-4718  
sg@hikvision.com

**Hikvision Spain**  
T +34-91-737-16-55  
info.es@hikvision.com

**Hikvision Tashkent**  
T +99-87-1238-9438  
uzb@hikvision.ru

**Hikvision Hong Kong**  
T +852-2151-1761  
info.hk@hikvision.com

**Hikvision Russia**  
T +7-495-669-67-99  
saleru@hikvision.com

**Hikvision Korea**  
T +82-(0)31-731-8817  
sales.korea@hikvision.com

**Hikvision Poland**  
T +48-22-460-01-50  
info.pl@hikvision.com

**Hikvision Indonesia**  
T +62-21-2933759  
Sales.Indonesia@hikvision.com

**Hikvision Colombia**  
sales.colombia@hikvision.com